



Catalogue
CATERING
Chapter
DISHWASHING

Model
CCO-160 I CW 400V 3N 60Hz

19048575

12/04/2019

CONVEYOR DISHWASHER CCO-160 I CW

All the main parts are manufactured in AISI-304 anti-corrosion stainless steel: tanks, washing and rinsing arms, rinsing jets, doors, basket conveyance system, boiler and metal tubes.
 Upwards-opening double panel door.
 Tank tray filters made of AISI-304 stainless steel, easy to access and remove for cleaning and access to the tank.
 Safety filter for pump suction.
 Rinsing boiler with heat insulation.
 Easy access for installation. Electrovalve located on one side (no need to remove panels to connect the machine).
 Electrical panel designed for easy connection of dosers for liquid and solid detergents, rinse aid, limit switches, supplementary emergency stop button.
 Washing arms easily removable as a set, for cleaning, with a plug on each branch providing access for cleaning inside.
 Rinse jets easily dismountable and removable.
 System of electronic regulation of speeds by means of frequency shifter.
 Configurable electronic temperature control:
 - Wash (50 - 65 °C)
 - Rinse (70 - 85 °C)
 Guarantor of rinse at 85 °C.
 Pressure regulator for flow control.
 Emergency stop button incorporated.
 Extra anti-entrapment protection system at the entrance, mounted on the AS-260 splash guard supplement (optional).
 Open door blocking system.
 IPX4 protection system.
 System for detection of blockage of conveyor carriage and automatic reverse function.
 High-power washing system with 4 upper and 4 lower washing branches.
 3 washing programs: deep, medium and high capacity.
 Double effect rinse.
 Energy-saving system: reduces consumption by halting operation of the pumps, and by passing the heating of the rinse to stand-by mode (70 °C).
 Auto-timer which deactivates the conveyor motor after a pre-set period of inactivity (10 minutes).
 Energy saving system in the wash: the wash does not start up until it detects the passage of the basket.
 Rinse saving system. The rinse stops when the basket has left, saving water and energy.
 Model prepared for entrance of baskets from the left side.
 Model prepared for a cold water connection inlet (Inlet temperature < 50°C)

Equipment included:

2 base baskets, CT-10
 2 baskets for plates CP-16/18, 1 basket for glasses CV-16/105, 1 basket for cutlery CT-10 R
 Limit switch included.

DIMENSIONS

X Width	1180 mm	X Gross width	1530 mm
Y Depth	790 mm	Y Gross depth	955 mm
Z Height	1560 mm	Z Gross height	1950 mm
Net Weight	211,0 kg	Gross Weight	306,0 kg
Net volume	2,225 m3	Gross volume	2,849 m3

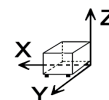

ELECTRICITY TECHNICAL SPECIFICATIONS

Electric power	31,600 kW
Heating power	30,00 kW
Voltage	400V - 3N
Amperage	51,3
Electric frequency	60Hz

WATER TECHNICAL SPECIFICATIONS

Pressure	H2O: 200-400kPa(2-4bar)
Water max consumption	240,00 L/h

CONNECTIONS TECHNICAL SPECIFICATIONS

230 V three-phase wiring	3X25+T - 100 A
Three-phase +N 40V wiring	4X16+T - 80 A
Hot diameter diameter	3/4"
Drain 1 diameter	38



Catalogue
CATERING

Chapter
DISHWASHING

Model
CCO-160 I CW 400V 3N 60Hz

19048575

12/04/2019

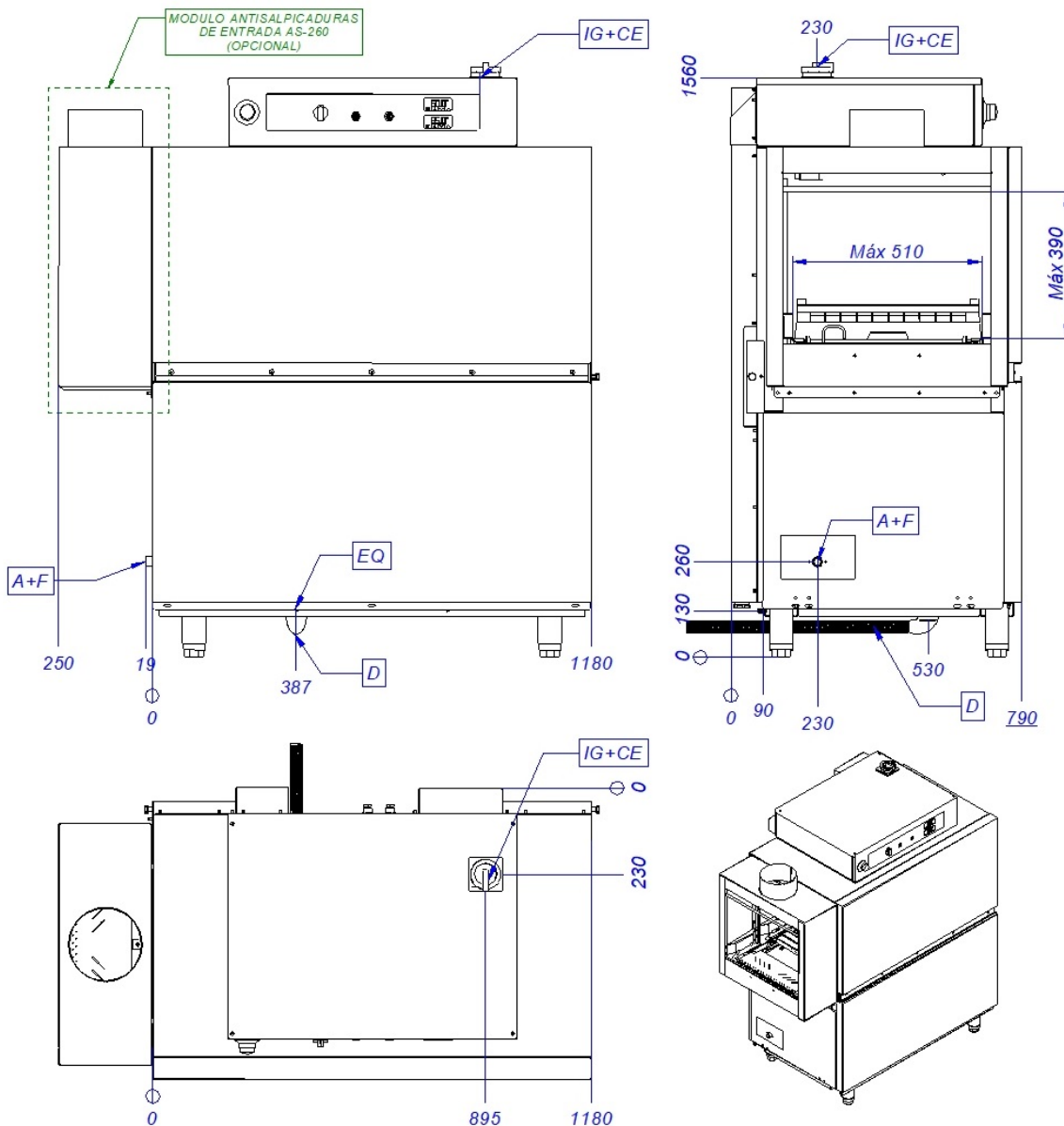

A+F	Entrada de agua + filtro	Water inlet & filter	Arrivée d'eau et filtrer
CE	Alimentación eléctrica	Power supply	Connexion électrique
D	Desagüe	Drain	Vindage
EQ	Toma equipotencial	Equipotential bonding terminal	Connexion Équipotentielle
IG	Interruptor general	General switch	Interrupteur général